



RSFUPS108

v.1.2

**RSFUPS108 10-ports switch with buffer power supply
for 8 IP cameras, RACK mounted**

EN

Edition: 4 from 14.02.2019

Supersedes the edition: 3 from 09.03.2018



Features:

- DC 52 V uninterruptible power supply of 8 IP cameras
- Switch 10 ports
8 PoE 10/100 Mb/s ports, (1÷8 ports) (data and power supply)
2 ports 10/100/1000 Mb/s (ports G1/TP, G2/TP) (UpLink)
- 2 ports 10/100/1000 Mb/s SFP (G1/SFP, G2/SFP ports)
- 30 W for each PoE port, supports devices compliant with the IEEE802.3af/at (PoE+) standard
- Supports auto-learning and auto-aging of MAC addresses (1K size)
- battery charging and maintenance control
- excessive discharging (UVP) protection
- battery output protection against short circuit and reverse connection
- battery charge current: 0,5 A (batteries 2x7 Ah / 2x17 Ah)
- Approximate backup time: 5 h 30 min
- acoustic indication of failure
- LED optical indication: AC, DC, TEMP, LoB, ALARM
- the ALARM technical output of collective failure – relay type, activated by:
 - 230 V power loss
 - low voltage of the PSU (<23 V)
 - too high temperature of the PSU (>70 °C)
 - the PSU failure
- protections:
 - SCP short-circuit protection
 - overvoltage protection
 - overload protection OLP
- forced cooling (fan)
- warranty – 2 year from the production date

Example of use.

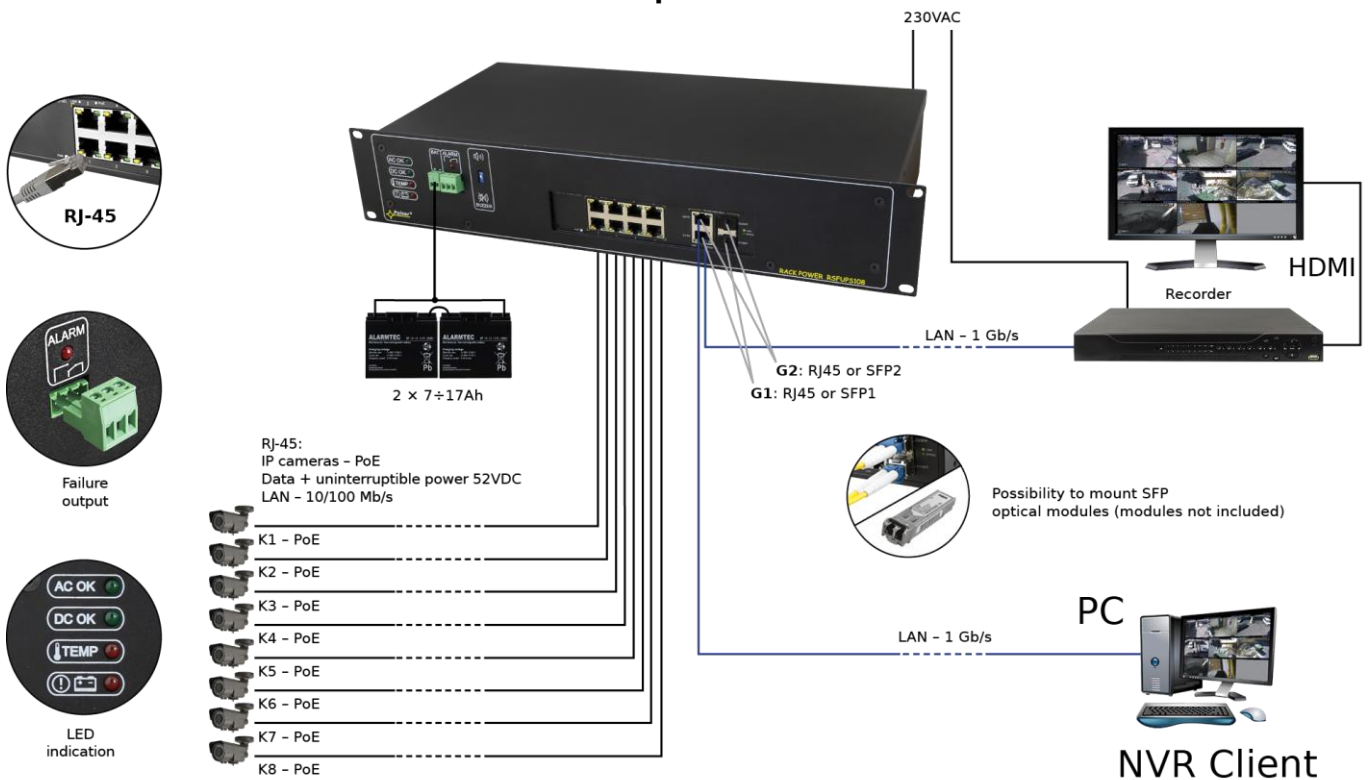

CONTENTS:

1. Technical description.
 - 1.1. General description
 - 1.2. Block diagram
 - 1.3. Description of components and connectors
 - 1.4. Specifications
2. Installation.
 - 2.1. Requirements
 - 2.2. Installation procedure
3. Indication of the device operation.
 - 3.1. LED indication of operating status
 - 3.2. Optical indication of the switch operation
 - 3.3. Technical output
 - 3.4. Acoustic indication
4. Operation and use.
 - 4.1. Overload or short circuit of the PSU output
 - 4.2. Battery-assisted operation
 - 4.3. Maintenance

1. Technical description.

1.1. General description.

The RSFUPS108 is a complete solution for power supply and battery backup of 8 IP cameras (52 V DC power supply) in RACK 19" standard.

The main elements of this system include:

- 10 ports PoE switch
- buffer power supply 27,6 V unit which can accommodate two 12 V batteries
- a converter (DC/DC52230) increasing the voltage to 52 V DC (supply of the PoE switch)

In case of mains power loss, a battery back-up is activated immediately.

The approximate backup time is given assuming that all output ports are used (using typical devices and 17 Ah batteries). The electricity consumption for own needs and the energy efficiency of the power intake track were taken into account. The exact description of how to perform the calculations can be found at: ["Approximate backup time - assumptions for calculations"](#).

Automatic detection of any devices powered in the PoE/PoE+ standard is enabled at the 1 – 8 ports of the switch. The G1/TP, G2/TP ports is used for connection of another network device via RJ45 connector. The switch is fitted with SFP slots (marked as G1/SFP and G2/SFP); the use of fiber optic module (GBIC) allows fiber optic transmission. The LED lights at the front panel indicate the operating status of the device.

The switch is fitted with the ALARM technical output of collective failure. In the case of failure, a LED light is activated, which is accompanied by switching of relay contacts and acoustic indication.

The PoE technology ensures a network connection and reduces installation costs by eliminating the need to supply a separate power cable for each device. This method allows supplying other network devices, such as IP phone, wireless access point or router.

1.2. Block diagram.

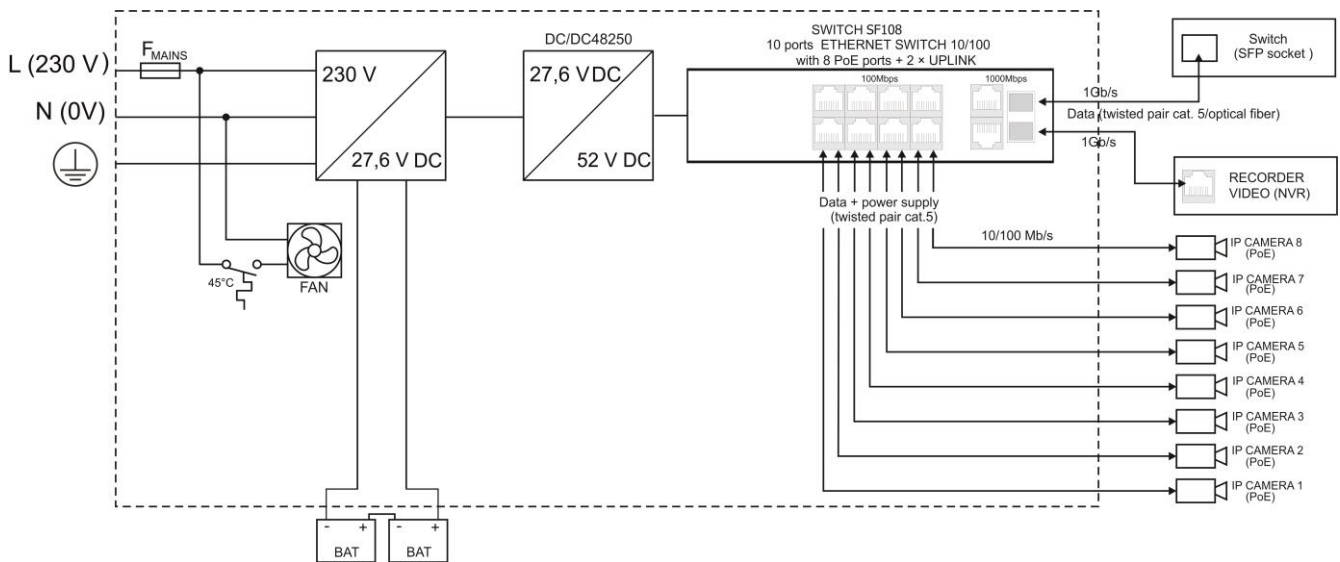



Fig.1. The block diagram of the PSU.

1.3. Description of components and connectors.

Table 1. (See Fig. 2, 3)

Element no. [Fig. 2]	Description
①	AC OK – green LED, indicating the presence of 230 V voltage
②	DC OK – green LED, indicating the presence of DC voltage
③	TEMP – red LED, indicating too high temperature of the power supply (>70 °C)
④	LoB – red LED, indicating too low battery voltage (<23 V)
⑤	LED ALARM – red LED collective failure indication

⑥	BAT – battery output
⑦	ALARM – technical output of collective failure – relay
⑧	BUZZER, micro switch , turning ON / OFF of acoustic indication  switch in the top position, indication ON  switch in the down position, indication OFF
⑨	PoE port 1÷8 for cameras IP connection (data + power supply)
⑩	2 x UPLINK ports (G1/TP, G2/TP)
⑪	2 x UPLINK ports (G1/SFP, G2/SFP)
⑫	230 V AC INPUT , power socket 230 V, power cable 1,5 m included
⑬	F_{MAINS} , fuse in the supply circuit 230 V, T 3,15 A/250 V

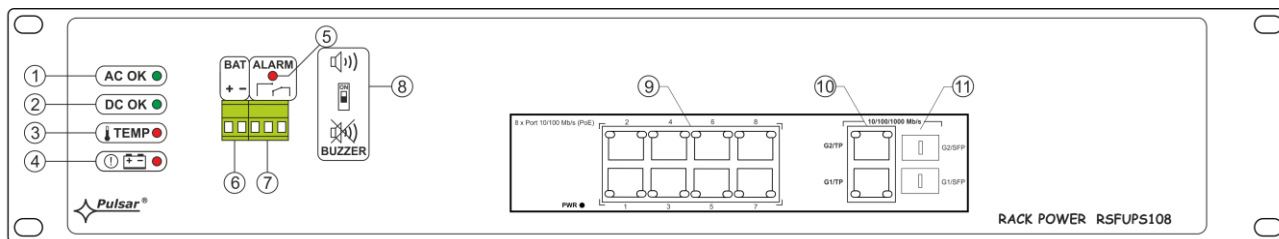

Fig. 2. The front power of the power supply unit.

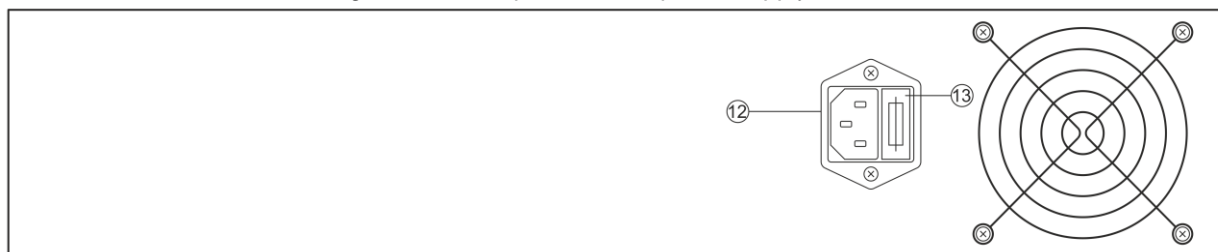

Fig. 3. Rear panel of the power supply.

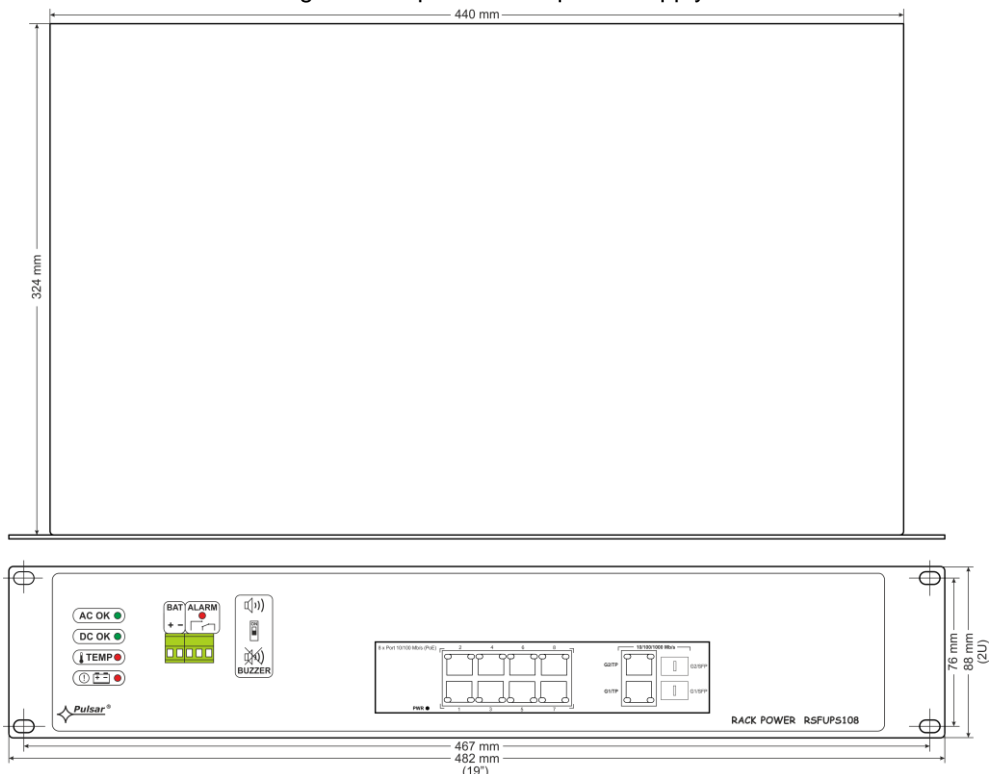

Fig.4. The view of the PSU.

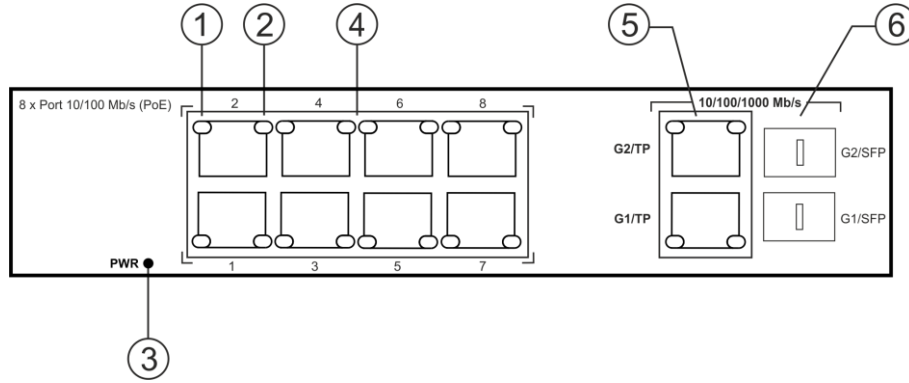

Fig.5. The view of the switch.

Table 2. (See Fig. 5).

Element no. [Fig. 2]	Description
①	LINK - yellow LED - indicating the LAN connection status
②	PoE - green LED indicating voltage at the PoE port
③	PWR - green LED indicating the supply voltage of the Switch
④	PoE port 1÷8 for cameras IP connection (data + power supply)
⑤	2 x UPLINK ports (G1/TP, G2/TP)
⑥	2 x UPLINK ports (G1/SFP, G2/SFP)

1.4. Specifications.

- parameters of the switch (tab.3)
- electrical parameters (tab.4)
- mechanical parameters (tab.5)
- operation safety (tab.6)
- operating parameters (tab.7)

Parameters of the switch (tab. 3).

Ports	8 x PoE (10/100 Mb/s) (RJ-45) 2 x UPLINK (10/100/1000 Mb/s) (RJ-45) 2 x UPLINK (10/100/1000 Mb/s) (SFP) with connection speed auto-negotiation and MDI/MDIX Auto Cross
PoE power supply	IEEE802.3af/at (1÷8 ports), 52 V DC / 30 W at each port *
Protocols, Standards	IEEE802.3, 802.3u, 802.3 x CSMA/CD, TCP/IP
Forwarding rate	10BASE-T: 14880 pps/port 100BASE-TX: 148800 pps/port
Bandwidth	1,6 Gbps
Transmission method	Store-and-Forward
Optical indication of operation	Switch power supply; Link/Act; PoE Status

* The given value of 30 W per port is the maximum value. The total power consumption should not exceed 96 W.

Electrical parameters (tab. 4).

Mains supply	~230 V; 50 Hz
Current up to	1,1 A
Supply power	110 W max.
Output voltage at the PoE ports	52 V DC – maintained regardless of the state of battery charge
The output current at the PoE ports	8 x 0,6 A Σ=2 A (max.)
Battery charge current (batteries 2x7 Ah / 2x17 Ah, connect batteries in series)	0,5 A max. (+/-5 %)
Approximate backup time	5 h 30 min
Short-circuit protection SCP and overload protection OLP	105 % ÷ 150 % of the PSU power, manual restart (failure requires the disconnection of the DC output)
PSU current consumption	200 mA/27,6 V
Battery circuit protection SCP and reverse polarity connection	melting fuse

Excessive discharge protection UVP	$U < 19 \text{ V } (+/-5 \%)$ – disconnect of connection battery
Optical indication of operation:	LED: AC, DC, TEMP, LoB, ALARM, LINK, PoE
Acoustic operation indication:	Piezoelectric indicator $\sim 75 \text{ dB}/0,3 \text{ m}$
The ALARM technical output of collective failure	Relay type: 1 A@ 30 V DC/50 V AC
The F_{MAINS} fuse in the 230 V power supply circuit	T 3,15 A

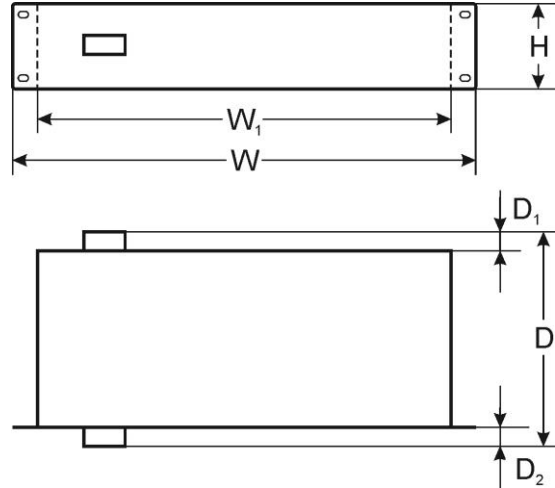

Mechanical parameters (tab. 5).

Mounting dimensions	$W=19''$, $H=2U$, $D=368$
Dimensions	$W=482$, $W_1=442$, $H=88$, $D=368$, $D_1=32$, $D_2=10$ [$\pm 2 \text{ mm}$]
Fixation	four-point butt mounting to RACK profiles – the set include 4 M6 screws + cage nuts
Net weight	7,3 kg / 7,9 kg
Enclosure	Steel plate RAL 9005, black
Connectors	230 V input: the IEC C14 socket with a fuse, power cable 1,5 m (included) Technical output ALARM : $\Phi 0,5-2,1$ (AWG 24-12) 0,5-1,5 mm ² Outputs of cameras PoE : sockets RJ45 8P8C Data output of the UPLINK recorder: RJ45 8P8C jack Battery output BAT : 6,3F-2,5
Notes	Forced cooling (fan).

Operation safety (tab.6).

Protection class PN-EN 60950-1:2007	I (first)
Protection grade PN-EN 60529: 2002 (U)	IP20
Electrical strength of insulation: - between input and output circuits of the PSU - between input circuit and protection circuit - between output circuit and protection circuit	3000 V AC min. 1500 V AC min. 500 V AC min.
Insulation resistance: - between input circuit and output or protection circuit	100 M Ω , 500 V DC

Operating parameters (tab.7).

Environmental class	II
Operating temperature	-10 °C...+40 °C
Storage temperature	-20 °C...+60 °C
Relative humidity	20 %...90 %, without condensation
Vibrations during operation	unacceptable
Impulse waves during operation	unacceptable
Direct insulation	unacceptable
Vibrations and impulse waves during transport	According to PN-83/T-42106

2. Installation.

2.1. Requirements.

The PSU RACK shall be mounted by a qualified installer with appropriate permissions and qualifications for 230 V installations and low-voltage installations (required and necessary for a given country). The device shall be mounted in confined spaces, according to the environment class II, with normal air humidity (RH=90 % max. without condensation) and the temperature from -10 °C do +40 °C.

Before installation, prepare a Switch'a load balance.

The given value of 30 W per port is the maximum value referring to a single output. The total power consumption should not exceed 96 W when all PoE ports are being used. The increased demand for power is particularly evident in the case of cameras with heaters or infrared illuminators - when launching these features, the power consumption increases rapidly, which may adversely affect the operation of the switch.

As the PSU is designed for a continuous operation and is not equipped with a power-switch, therefore an appropriate overload protection shall be guaranteed in the power supply circuit. Moreover, the user shall be informed about the method of unplugging (usually through assigning an appropriate fuse in the fuse-box). The electrical system shall follow valid standards and regulations.

2.2. Installation procedure.

1. Before installation, cut off the voltage in the 230 V power-supply circuit.
2. Mount the power supply in a RACK 19" cabinet as shown below:



- Mount M6 cage nuts



- Secure the enclosure with 4xM6 screws

3. Connect the batteries in series/parallel to the + BAT- terminals:
 - battery output (+): terminal BAT+
 - battery output (-): terminal BAT-

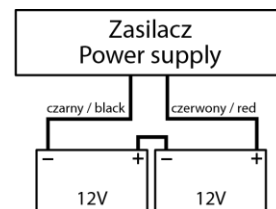

4. Connect the ~230 V power cord with the IEC C13 plug (included) to the 230 V power supply and turn on the power (~230 V).
5. Connect the camera cables to the RJ45 connectors (PoE connectors) and connect the recorder to the network (the UPLINK connector).
6. Make the following technical connections when needed:
ALARM – technical output of collective failure indication
7. Check the optical indication of the switch operation.

3. Indication of the device operation.

3.1. LED indication of operating status.

The PSU has 5 LED lights at the front panel:



GREEN LED:

- on – the PSU is supplied with 230 V
- off – no 230 V supply



GREEN LED:

- on – DC voltage at the output of the switch mode PSU
- off – no DC voltage at the output of the switch mode PSU



RED LED:

- on – failure
- off – no failure



RED LED:

- ON – too high temperature of the switch mode power supply (>70 °C)
- OFF – standard temperature of the switch mode power supply

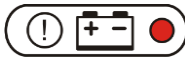

RED LED:

- on – battery voltage <23 V
- off – battery voltage >23 V

3.2. Optical indication of the switch operation:

OPTICAL INDICATION OF THE SWITCH'S POWER SUPPLY

<p>GREEN LED LIGHT (Power) Indication of the switch's power supply</p>	<p>PWR ●</p>	<p>OFF – no power supply of the switch ON – power supply on, normal operation</p>
---	---------------------	---

OPTICAL INDICATION OF THE SWITCH'S POWER SUPPLY (1÷8)

<p>GREEN LED LIGHT (PoE) Indication of the PoE power supply at the RJ45 ports</p>		<p>OFF - no power supply at the RJ45 port (the device is not connected or not compliant with the IEEE802.3af/at standard) ON – supply at the RJ45 port Blinking – short-circuit or output overload</p>
<p>YELLOW LED LIGHT (LINK) The connection status of LAN devices, 10 MB/s or 100 Mb/s and data transmission</p>		<p>OFF - no connection ON - the device is connected; 10 Mb/s or 100 Mb/s Blinking – data transmission</p>

OPTICAL INDICATION AT THE UPLINK PORTS

<p>YELLOW LED LIGHT (LINK)</p>	<p>OFF - no connection ON - the device is connected Blinking – data transmission</p> <p>CAUTION! The operating status of the G1/TP, G1/SFP, G2/TP and G2/SFP slots is shown on the LEDs located near the RJ45 connector (see below).</p> <p>CAUTION! G1/TP and G1/SFP or G2/TP and G2/SFP sockets can not operate simultaneously. These are COMBO type sockets.</p>
<p>GREEN LED LIGHT (SPEED)</p>	<p>OFF – connection 10 Mb/s or 100 Mb/s ON - connection 1000 Mb/s</p> <p>CAUTION! The operating status of the G1/TP, G1/SFP, G2/TP and G2/SFP slots is shown on the LEDs located near the RJ45 connector (see below).</p> <p>CAUTION! G1/TP and G1/SFP or G2/TP and G2/SFP sockets can not operate simultaneously. These are COMBO type sockets.</p>

3.3. Technical output.

The power supply is fitted with the **ALARM** output of collective failure (relay type). A collective failure can be triggered by the following events:

- 230 V mains power failure
- Failure of the switch mode power supply
- Too high temperature of the switch mode power supply (>70 °C)
- Low battery voltage (<23 V)

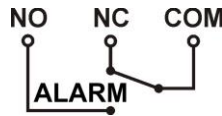

Fig. 5. Electrical diagram of the ALARM collective output of failure.



CAUTION! In Fig.5 the set of contacts shows a potential-free status of the relay, which corresponds to power supply failure.

3.4. Acoustic indication.

A collective failure is indicated by the piezoelectric indicator, 1 beep every second. The acoustic indication can be turned off by changing the ON / OFF position of the switch «»).



switch in the up position, indication ON



switch in the down position, indication OFF

4. Operation and use.

4.1. Overload or short circuit of the PSU output.

In case of overload, the output voltage is automatically shut off, and so is the LED indicator. The restoration of the voltage takes place immediately once the failure (overload) is over.

4.2. Battery-assisted operation.

In case of a main power outage, the device is immediately switched into a battery-assisted operation.



The PSU is equipped with the discharged battery disconnection system. During the battery-assisted operation, reducing voltage below 19 V at the battery terminals will cause battery disconnection.

4.3. Maintenance.

Any and all maintenance operations may be performed following the disconnection of the PSU from the power supply network. The PSU does not require performing any specific maintenance measures. In case of fuse replacement, use a replacement of the same parameters.



WEEE LABEL

Waste electrical and electronic equipment must not be disposed of with normal household waste. According to the European Union WEEE Directive, waste electrical and electronic equipment should be disposed of separately from normal household waste.

The power supply unit is adapted for a sealed lead-acid battery (SLA). After the operation period it must not be disposed of but recycled according to the applicable law.

Pulsar sp. j.

Siedlec 150, 32-744 Łapczyca, Polska
Tel. (+48) 14-610-19-40, Fax. (+48) 14-610-19-50
e-mail: biuro@pulsar.pl, sales@pulsar.pl
http:// www.pulsar.pl, www.zasilacze.pl