



1. Intended use:

The RACK 19" cabinet enables integrating CCTV, AC, I&HAS, RTV, LAN, or other systems in small companies or households. It is intended for devices manufactured in enclosures of the 19" standard. Due to the RACK cabinets, the devices are aesthetically mounted and protected against mechanical damage.

2. Specifications:



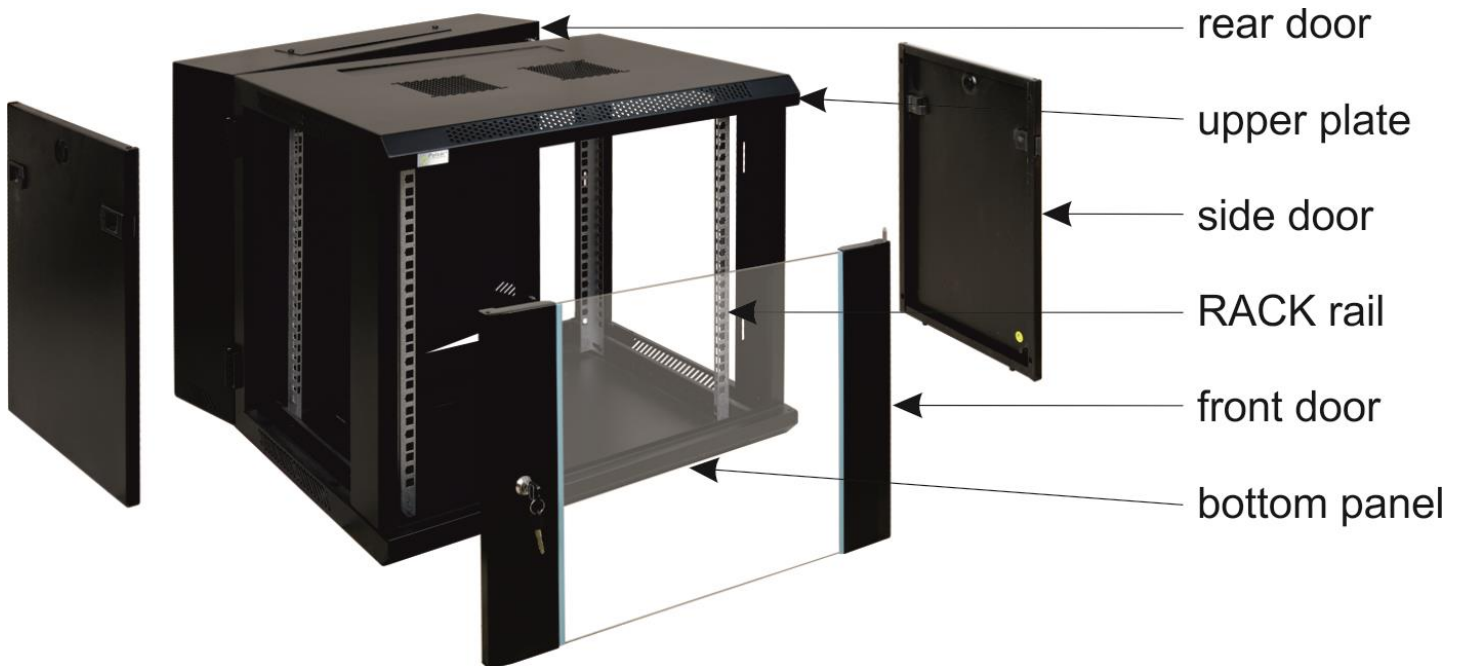

SPECIFICATIONS	
Mounting dimensions:	W=19", H=9U, D=269mm
External dimensions:	W=600, H=501, D=600 [mm, +/-2]
Net/gross weight:	23,7 / 26,5 [kg]
Materials:	<ul style="list-style-type: none"> - RACK mounting rails: cold-rolled steel SPCC 1,5mm - cabinet: cold-rolled steel SPCC 1,2mm RAL 9004 - front door: 5mm toughened glass / SPCC 1,2mm RAL 9004 - side panels: cold-rolled steel SPCC 1,2mm RAL 9004 - rear door: cold-rolled steel SPCC 1,2mm RAL 9004
Static load:	70 kg
Use:	inside, IP20
Notes:	<ul style="list-style-type: none"> - adjustable distance between front and rear RACK rails (range - see point 5) - ventilation holes in the top panel (2 x 105x105mm - mounting dimensions) - cable ducts in the top and bottom door (273x60mm) - lockable front door – repeatable code (2 keys included) - lockable rear door – repeatable code (2 keys included) - possibility of reverse front door – opening left/right - side panels - lock assembly possible - RAZB16 (additional equipment) - ready-to-assemble
Declarations, warranty:	RoHS, 12 months from the date of purchase

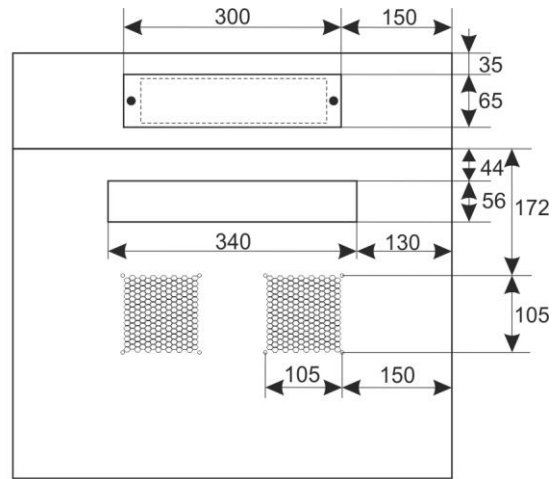
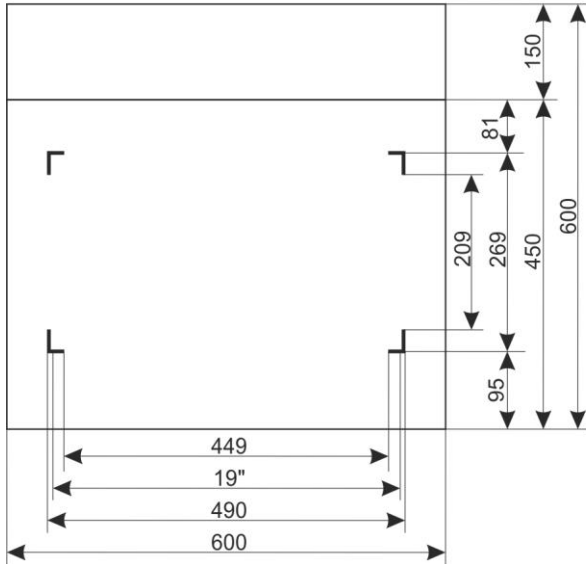
3. Structure of the cabinet.



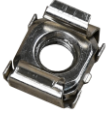

4. Components

Number	Component	Amount	Foto	Number	Component	Amount	Foto
1	RACK cabinet	1 pcs		4	M6 nut („cage nut“)	12 pcs	
2	M5 nut, spring washer	2 pcs		5	Cross and hex screwdriver	1 pcs	
3	M6x12 Phillips screw	12 pcs					

5. RACK 19" profiles – change of spacing

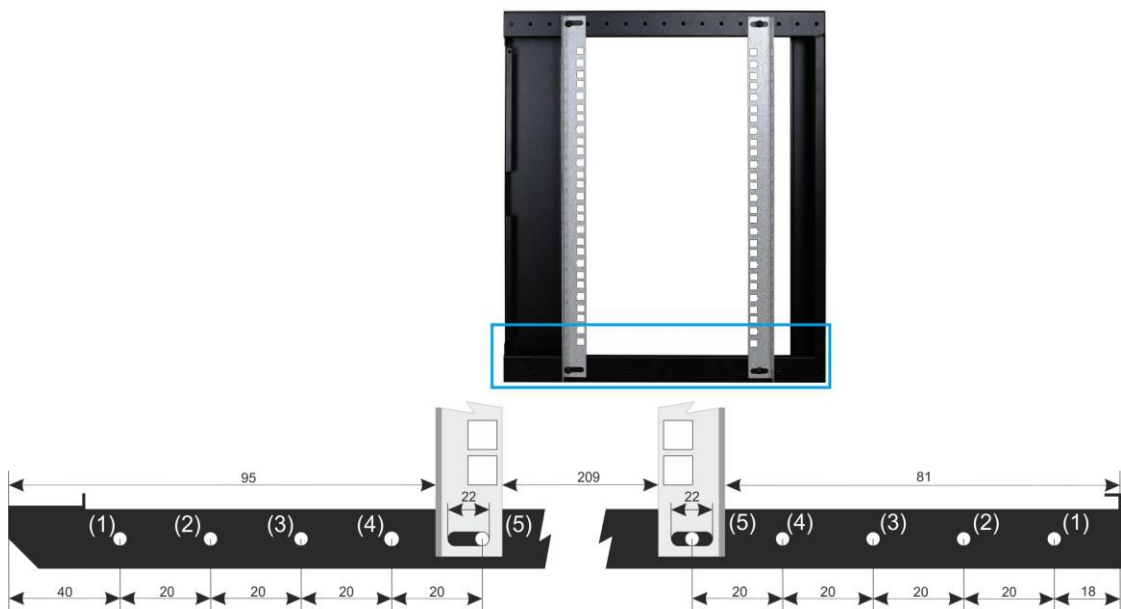

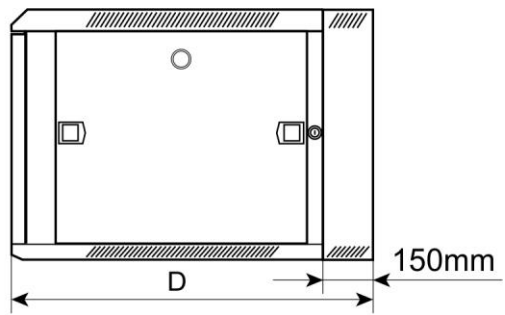
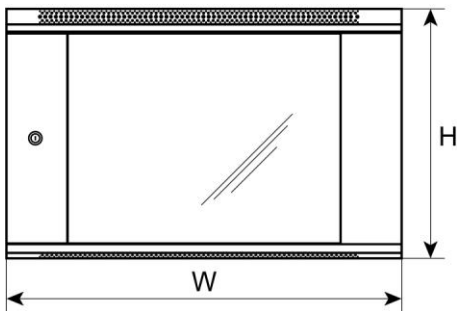

6. Assembly of RACK cabinet

Choose appropriate mounting pins depending on type of substrate.

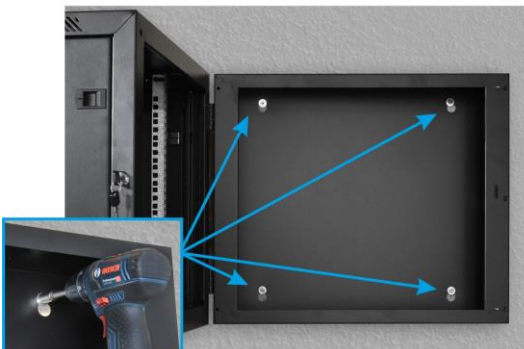
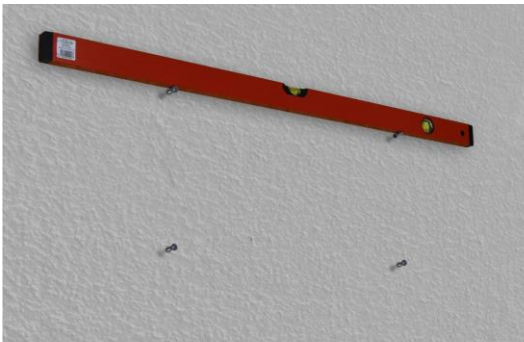

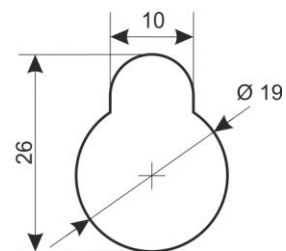
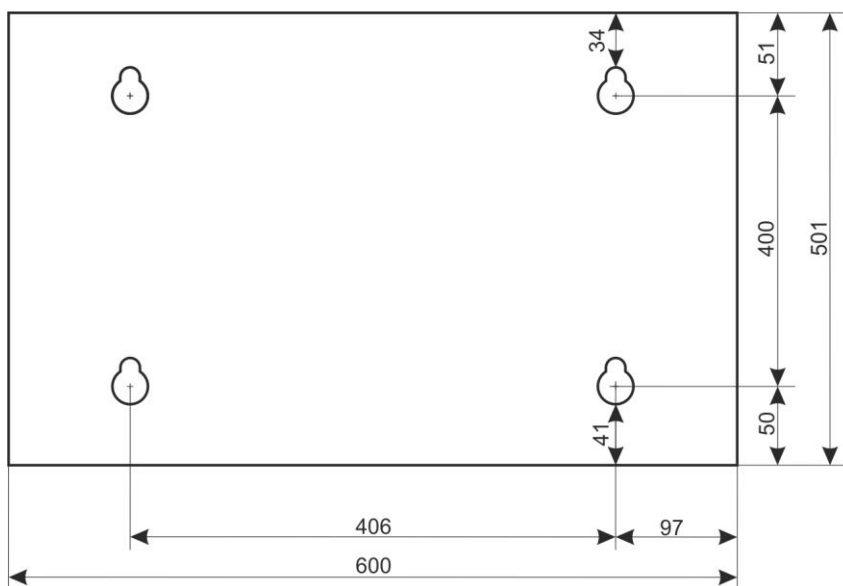

MANUFACTURER

Pulsar sp. j.

Siedlec 150, 32-744 Łąpczyca

Tel. 14-610-19-40, Fax. 14-610-19-50

e-mail: biuro@pulsar.pl, sales@pulsar.pl

http:// www.pulsar.pl, www.zasilacze.pl